

Product Specifications

DLP™ LED Display Engine



Model: VS-PE78RU

Information in this document is subject to change without notice.

**Mitsubishi Electric Corporation
Kyoto Works**

Date: April 01, 2014

VS-PE78RU model Specifications

(1) Image panel and light source

Type	DLP™ technology (0.95" DLP™ 1 chip) DarkChip3™, BrilliantColor™
Resolution	1400 x 1050 pixels
Light source	Redundant LED (RGB)
Light source average lifetime	100,000hours @ ADV.ECO mode 80,000hours @ Other modes

DLP and Digital Light Processing are trademarks of Texas Instruments.

(2) Electric specification

	Mode	Power consumption	Thermal dissipation
Power consumption Thermal dissipation (with 1 input board typ.)	BRIGHT	233W	200.4kcal/h (795BTU/h)
	NORMAL	147W	126.4kcal/h (502BTU/h)
	ECO	108W	92.9kcal/h (369BTU/h)
	ADV.ECO	88W	75.7kcal/h (300BTU/h)
Voltage range	AC 100 – 240V +/-10% , 50/ 60Hz +/-1Hz		
Operating current (100/240V)	3.2/1.4 Amp.		
Inrush current (100/240V)	30/60 Amp.		
Control signal input	RS-232C: D-Sub 9 pins		
	LAN: RJ45 x1 (10BASE-T/100BASE-TX)		
	D-Sub 9 pins x 2 (input, output) Mitsubishi original control link		
	Wire remote: F3.5Jack		
	IR Receiver		
Input board slot	Input board slot for optional input board x 2		
Input signal specification	Refer to (9) Optional input board specification		
Overlay function	Up to 4 windows per each screen.		

(3) Optical specification (Typical value)

	SXGA+ Mode	SXGA Mode
Light output @BRIGHT mode	1130ANSI Lumen	1010ANSI Lumen
Diagonal image size	50" – 80"	50" – 80"
Throwing distance (Lens unit top - Screen)	50": 736 +/- 7.8mm 60": 893 +/- 9.4mm 67": 1003 +/- 10.5mm 78.7": 1190 +/- 12.3mm	50": 789 +/- 8.3mm 67": 1074 +/- 11.2mm 70": 1124 +/- 11.7mm
Throw ratio (Exit pupil – Screen) / Screen width	0.770 (Nominal)	0.842 (Nominal)
Exit pupil – Lens unit top	44.5mm (Nominal)	
Contrast ratio	1600:1	
Brightness uniformity	95% at 90% image height	
Geometry distortion	0.2%	
Lateral color shift Red – Green Blue – Green	0.5pixel	

(4) Mechanical specification (Approximate value)

		Optical unit	Chassis box
Dimensions	Width	454mm/17.9"	249mm/9.8"
	Height	199mm/7.8"	262mm/10.3"
	Depth	307mm/12.1"	208mm/8.2"
Weight		13kg/27lbs	6kg/13lbs
Packing Dimensions	Width	875mm/34.4"	
	Height	410mm/16.1"	
	Depth	420mm/16.5"	
Packing weight		25kg/55lbs	
Accessories		Cube connection control cable Duct, Barrier	

(5) Environment

Temperature and humidity Condition at operation	10°C – 35°C (50°F – 95°F), 20% – 80% non condensing
Temperature and humidity Condition at storage	-20°C – 50°C (-4°F – 122°F), 20% – 80% non condensing

(6) Safety approval

Safety approval	UL60950-1, CSAC22.2No.60950-1, EN60950-1 K60950-1, AS/NZS60950.1, GB4943.1
EMC	FCC part15 Subpart B Class A ICES-003 Issue No.5 Class A EN55022 Class A, EN55024 EN61000-3-2, EN61000-3-3 KN22 Class A, KN24 AS/NZS CISPR 22 Class A GB9254 Class A, GB17625.1 VCCI Class A, JIS C 61000-3-2

(7) Parts reliability (Average lifetime)

Cooling fan	100,000hours
-------------	--------------

(8) Options

Remote control unit	R-XL50TX / R-XL51TX
Analog RGB input board	VC-B70G2
Digital RGB input board	VC-B70D2
Video input board	VC-B70V2
Daisy chain board	VC-B70DC
SDI input board	VC-B70SD1
Digital/Analog RGB input board	VC-B70DA2
LED unit	S-78LEA
Power cord (North America)	JC-PC3MA
Power cord (Europe)	JC-PC3ME
Power cord (China)	JC-PC3MC
Power cord (Japan)	JC-PC3MJ
Motorized adjustment tool	S-A70E

(9) Optional input board specification

Analog RGB input board: VC-B70G2

Signal input terminal (Analog RGB)		5BNC x1 HD Dsub15 x1
RGB Input scanning frequency	Signal resolution	VGA (640 x 480) – WUXGA (1920 x 1200) (Refer to attached “Supported signals list”)
	Horizontal	31.5kHz – 92kHz
	Vertical	49Hz – 85Hz
Pixel clock rate		25MHz – 162MHz
Functions		Scaling: shrink and zoom. Frame rate conversion.

Digital RGB input board: VC-B70D2

Signal input terminal (Digital RGB)		DVI-D (with HDCP) x2
RGB Input scanning frequency	Signal resolution	VGA (640 x 480) – WUXGA (1920 x 1200) (Refer to attached “Supported signals list”)
	Horizontal	31.5kHz – 92kHz
	Vertical	49Hz – 85Hz
Pixel clock rate		25MHz – 162MHz
Signal format		TMDS
Functions		Scaling: shrink and zoom. Frame rate conversion.

Video input board: VC-B70V2

Signal input terminal (Analog Video)		3BNC x2
Video input signals		NTSC, NTSC4.43 PAL, PAL-M, PAL-N, PAL-60, SECAM
Functions		Scaling: shrink and zoom. Frame rate conversion.

Daisy chain board: VC-B70DC

Signal input terminal		Analog RGB: HD Dsub15 x1 Digital RGB: DVI-D (with HDCP) x1 Analog Video: 3BNC x1
Signal output terminal		Digital RGB: DVI-D x1 (Daisy chain use only. Can not output HDCP signals.)
RGB Input scanning frequency	Signal resolution	VGA (640 x 480) – WUXGA (1920 x 1200) (Refer to attached “Supported signals list”)
	Horizontal	31.5kHz – 92kHz
	Vertical	49Hz – 85Hz
Video input signals		NTSC, NTSC4.43 PAL, PAL-M, PAL-N, PAL-60, SECAM
Pixel clock rate		25MHz – 162MHz
Functions		Scaling: shrink and zoom. Frame rate conversion. Daisy chain function (Up to 16 cubes)

SDI input board: VC-B70SD1

Signal input terminal		BNC x 1
Signal output terminal		BNC x 1 (for through output)
Input signals		3G-SDI (SMPTE424M): 1080p@50/59.94/60Hz HD-SDI (SMPTE292M): 1080i@50/59.94/60Hz 720p@50/59.94/60Hz SD-SDI (SMPTE259M-C): 480i@59.94Hz, 576i@50Hz
Gen lock input		Terminal: BNC x 1 Format: NTSC/PAL Black burst
Functions		Scaling: shrink and zoom. Frame rate conversion. Through output: (Up to 16 cubes @ HD-SDI, SD-SDI Up to 9 cubes @ 3G-SDI)

Digital/Analog RGB input board: VC-B70DA2

Signal input terminal		DVI-I (Digital with HDCP, Analog) x2
RGB Input scanning frequency	Signal resolution	VGA (640 x 480) – WUXGA (1920 x 1200) (Refer to attached “Supported signals list”)
	Horizontal	31.5kHz – 92kHz
	Vertical	49Hz – 85Hz
Pixel clock rate		25MHz – 162MHz
Signal format		TMDS
Functions		Scaling: shrink and zoom. Frame rate conversion. Digital cable equalizer function (Maximum 50m depending on the qualities of equipment and cable)

Supported signals list

RGB signals

Signal	Resolution	Refresh rate (Hz)	Line rate (kHz)
VESA	1920 x 1200	60.0	74.0
	1920 x 1080	60.0	67.5
	1680 x 1050	60.0	65.3
	1600 x 1200	60.0	75.0
	1440 x 900	59.9	55.9
	1400 x 1050	59.9	64.7
		60.0	65.3
		74.9	82.3
	1366 x 768	59.8	47.7
	1360 x 768	60.0	47.7
	1280 x 1024	60.0	64.0
		75.0	80.0
		85.0	91.1
	1280 x 960	60.0	60.0
	1280 x 800	59.8	49.7
	1280 x 768	59.9	47.8
	1280 x 720	60.0	45.0
	1152 x 864	75.0	67.5
	1024 x 768	60.0	48.4
		70.1	56.5
		75.0	60.0
		85.0	68.7
	848 x 480	60.0	31.0
	800 x 600	56.3	35.2
		60.3	37.9
		72.2	48.1
		75.0	46.9
		85.1	53.7
	720 x 400	85.0	37.9
	640 x 480	59.9	31.5
		72.8	37.9
		75.0	37.5
		85.0	43.3
640 x 400	85.1	37.9	
640 x 350	85.1	37.9	
PC	1400 x 1050	60.0	64.0
	1280 x 1024	60.0	63.4
	1280 x 960	75.0	75.0
	1152 x 864	70.0	63.9
		85.1	77.5
640 x 400	70.1	31.5	
	84.1	37.9	
Mac	1152 x 870	75.0	68.6
	1024 x 768	74.9	60.2
	832 x 624	74.5	49.7
	640 x 480	66.7	35.0
Unix	1280 x 1024	59.9	64.6
		71.2	75.1
		72.0	78.1
		76.1	81.1
HDTV	1920 x 1080	50.0	28.1
		59.9	33.7
	1280 x 720	50.0	37.5
		59.9	45.0

Y/Cb/Cr (Y/Pb/Pr) signals

Signal	Resolution	Refresh rate (Hz)	Line rate (kHz)
1125p/1080p	1920 x 1080	50.0	56.3
		59.9	67.4
1125i/1080i	1920 x 1080	50.0	28.1
		59.9	33.7
750p/720p	1280 x 720	50.0	37.5
		59.9	45.0
625p/576p	720 x 576	50.0	31.3
525p/480p	720 x 480	59.9	31.5

Optional input board appearance

VC-B70G2

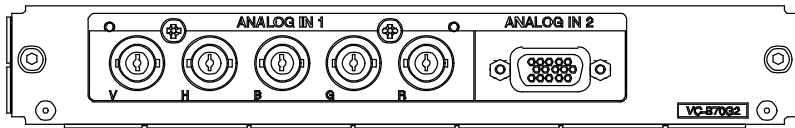

VC-B70D2

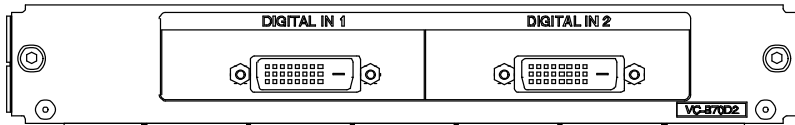

VC-B70V2

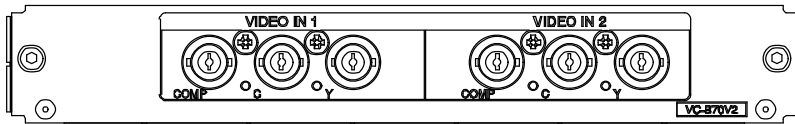

VC-B70DC

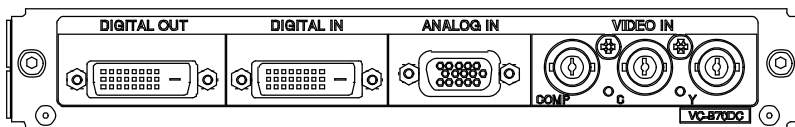

VC-B70SD1

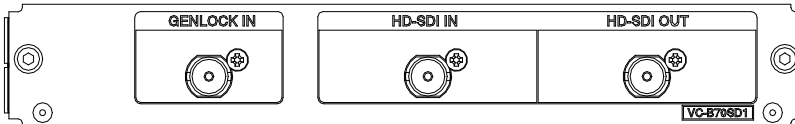

VC-B70DA2

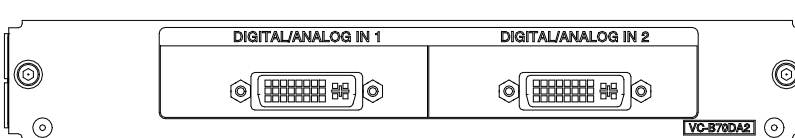

**External dimensions
[Optical unit]**

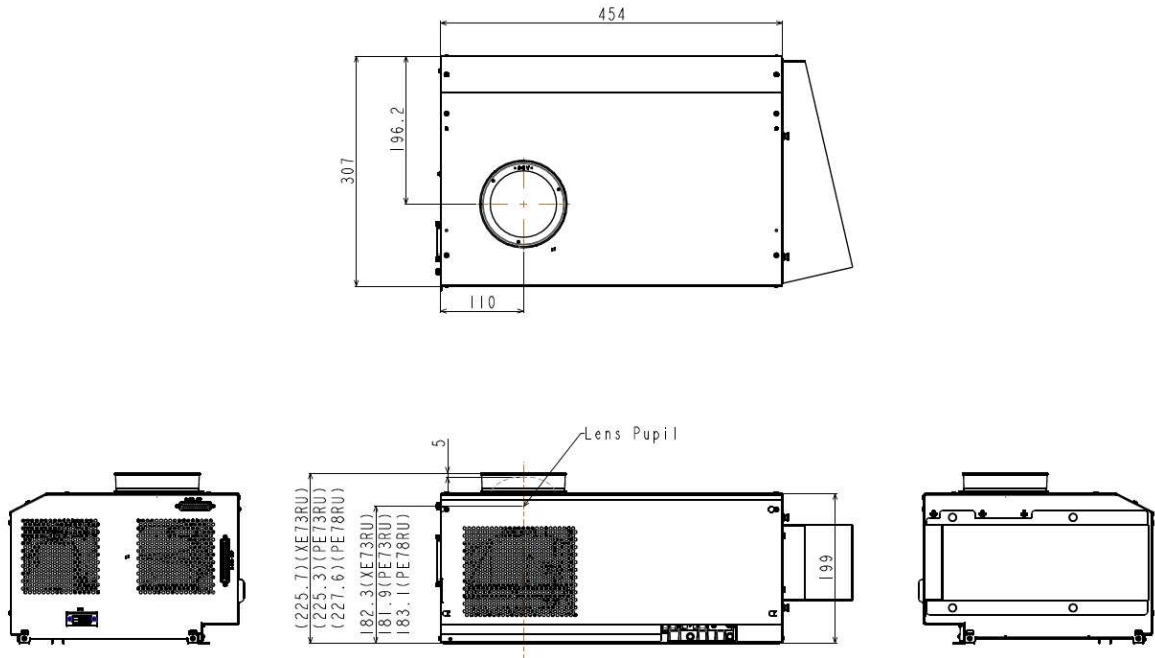

[Chassis box]

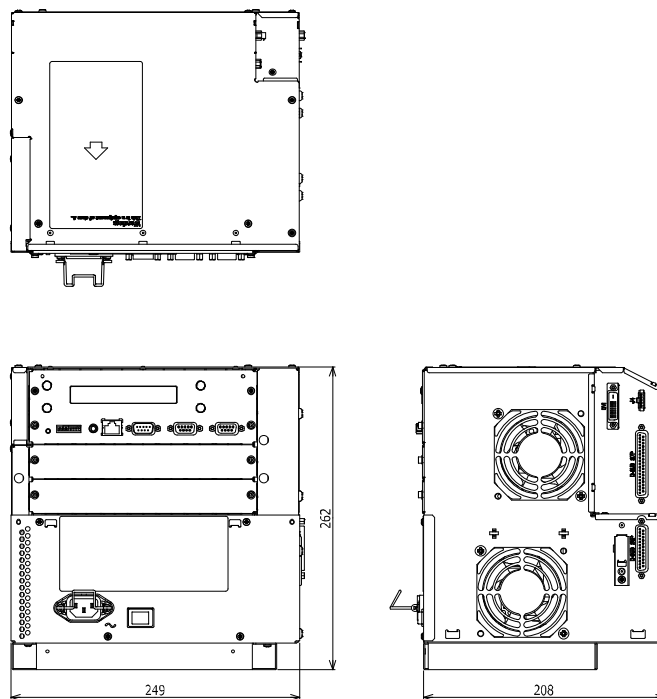

Packing specification

